

# GeoMax Zone20 H



**GEOMAX**

**Quick Guide**  
Version 1.2

# 1 Important Information about your Instrument

---





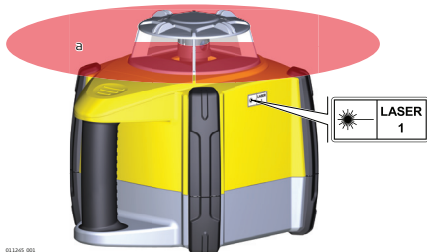









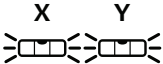

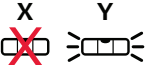
## Labelling



a) Laser beam

---

		 <p><b>H.I. ALERT</b></p>
		
		
		
		

**Li-Ion**

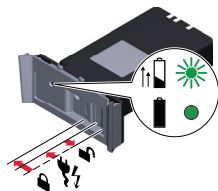

**Alkaline**  
4x D-cell (LR20)

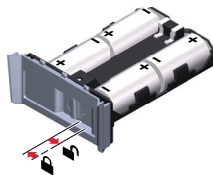

**Battery (Li-Ion + Alkaline)**

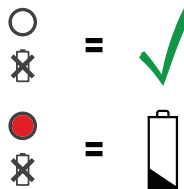

ZRB35

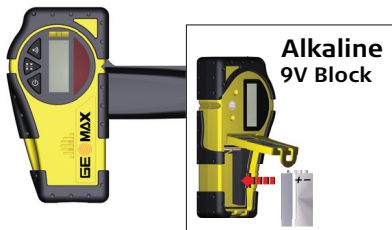

0/1



±1 mm, ±3 mm



ZRP105

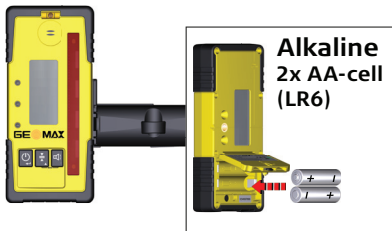

0/1



±1 mm, ±2 mm, ±3 mm



**ZRD105**

 $\frac{\circ}{I}$ 

 $\pm 0.5 \text{ mm}, \pm 1 \text{ mm},$   
 $\pm 2 \text{ mm}, \pm 3 \text{ mm}, \pm 5 \text{ mm}$ 

1x



## Setting Forms

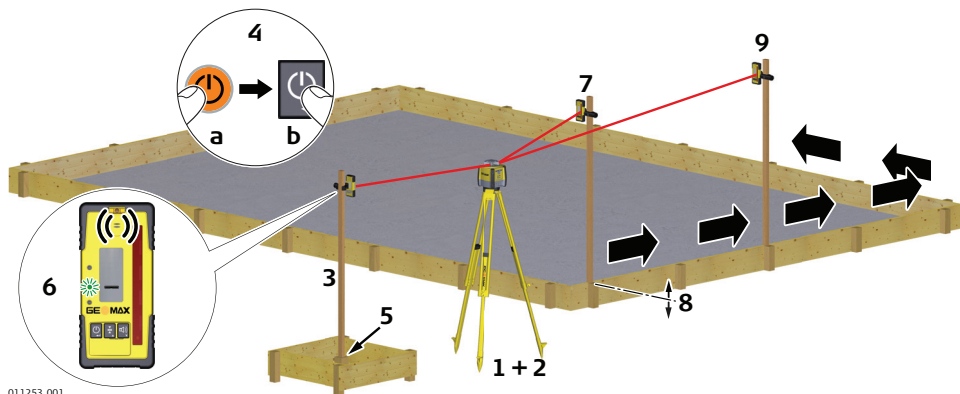

011253.001

Checking Grades

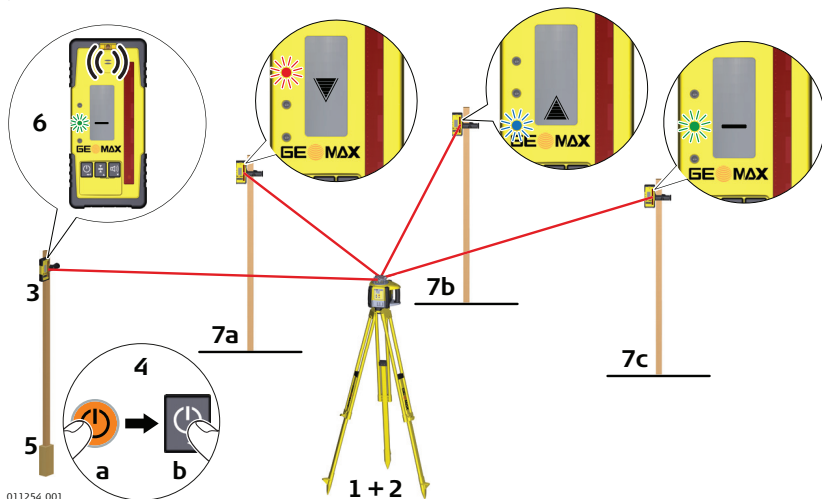

011254\_001



## Manual Grading

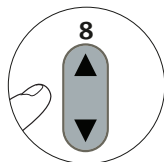
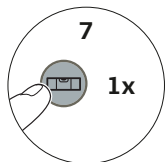
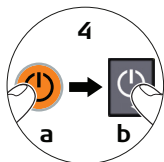

011255\_001

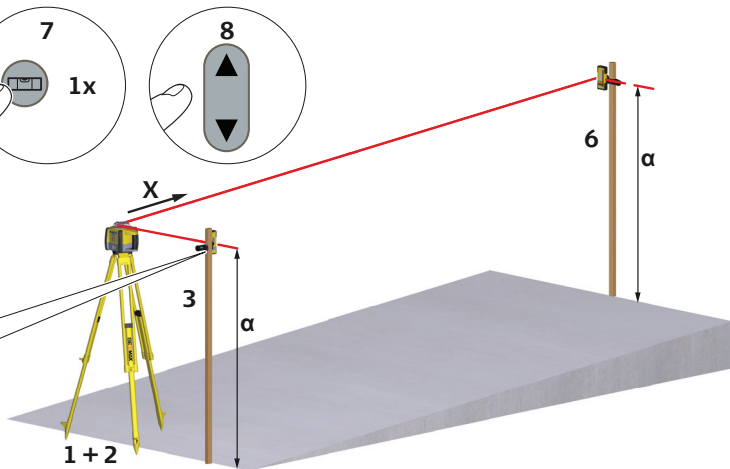

### Conformity to national regulations

For products which do not fall under R&TTE directive:



Hereby, GeoMax AG, declares that the product/s is/are in compliance with the essential requirements and other relevant provisions of the applicable European Directives. The declaration of conformity is available from GeoMax AG.

### Dangerous Goods Regulations

The products of GeoMax are powered by Lithium batteries.

Lithium batteries can be dangerous under certain conditions and can pose a safety hazard. In certain conditions, Lithium batteries can overheat and ignite.



When carrying or shipping your GeoMax product with Lithium batteries onboard a commercial aircraft, you must do so in accordance with the **IATA Dangerous Goods Regulations**.



GeoMax has developed **Guidelines** on "How to carry GeoMax products" and "How to ship GeoMax products" with Lithium batteries. Before any transportation of a GeoMax product, we ask you to consult these guidelines on our web page (<http://www.geomax-positioning.com/dgr>) to ensure that you are in accordance with the

IATA Dangerous Goods Regulations and that the GeoMax products can be transported correctly.



Damaged or defective batteries are prohibited from being carried or transported onboard any aircraft. Therefore, ensure that the condition of any battery is safe for transportation.

---

# GeoMax Zone20 H Series



Laser class 1 product in accordance with  
IEC 60825-1 (2014-05)



**841851-1.2.0**

Original text

© 2016 GeoMax AG, Widnau, Switzerland



**GeoMax AG**  
[www.geomax-positioning.com](http://www.geomax-positioning.com)