

***PRO SHOT™ Slope Lasers
A52 \ A52 MAGNUM***

Operations Guide



Introduction

Thank you for purchasing a Pro Shot™ AS2 or AS2 MAGNUM laser system. You now have superior laser accuracy and productivity available for all your projects.

Both Pro Shot™ AS2 laser models are rugged, reliable, high quality products, backed by the industry leading Guardian 36 month warranty. Warranty details are printed in the back of this manual.

Please take the time to thoroughly read this manual. It contains vital information on how to safely get the most from your investment in high performance laser technology.

Contents

Battery Installation	1
Controls and Displays	2
Safety	4
Initial Setup Guidelines	6
Level Setup	7
Slope setup	8
Compound Slope Setup	10
Checking & Adjusting Calibration	12
R7 • AS2 System Receiver	14
R8 • AS2 MAGNUM System Receiver	15
Maintenance and Troubleshooting	16
Guardian Warranty and Specifications	17

Getting Started

Case contents (will vary - may be ordered with different accessories)

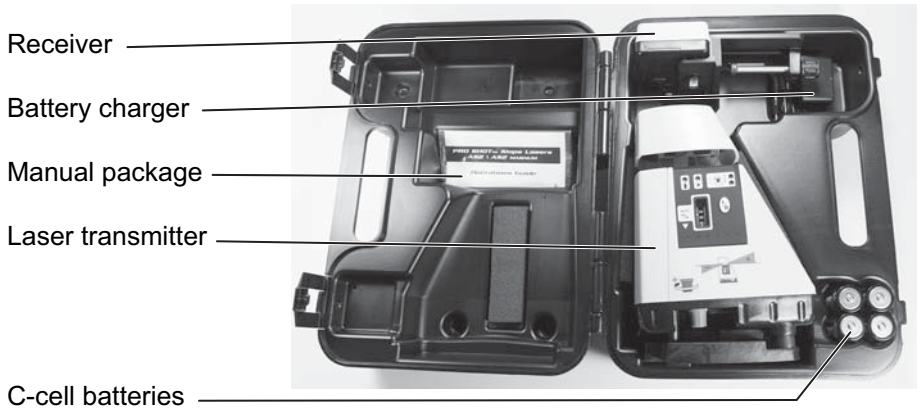

Battery installation

Always follow recycling directives for electronic waste



1 Pull on tab at base of door to remove



2 Install batteries according to the instructions molded on the battery holder



3 Hook battery door under metal plate below lighthouse and push at base of door to latch



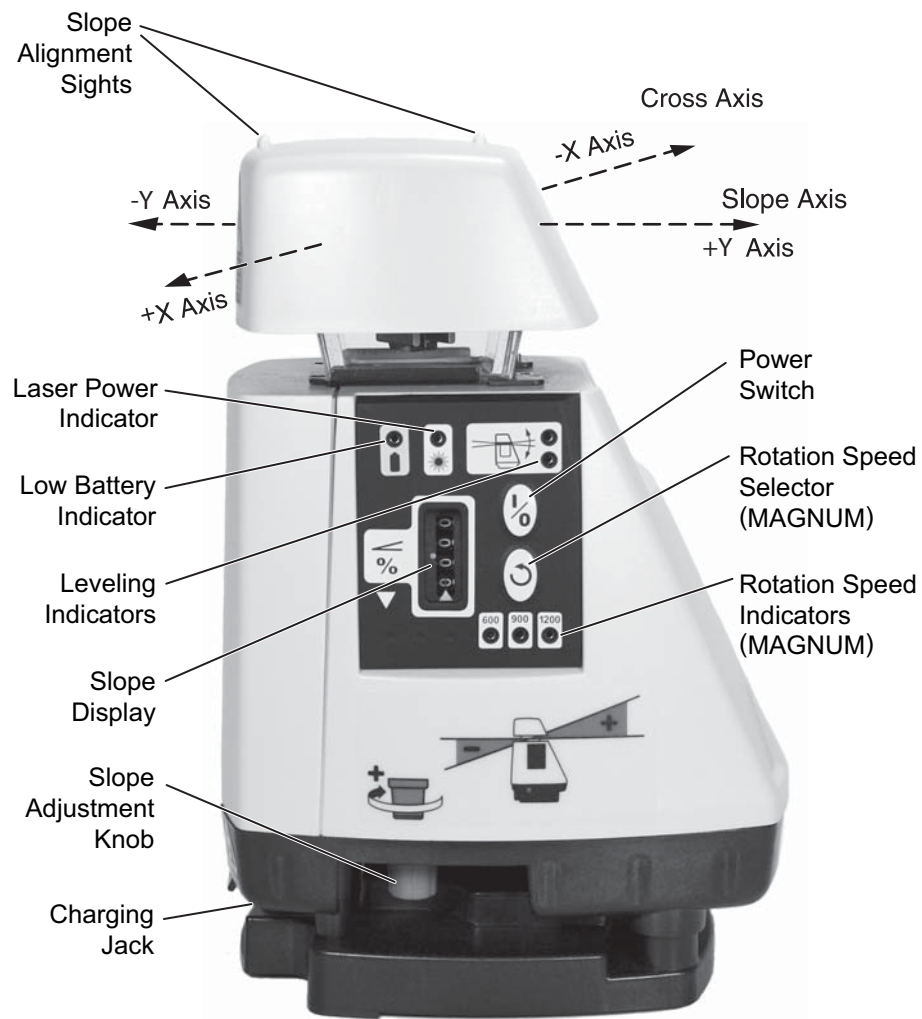

Note: Controls and displays are the same for both models except that the AS2 MAGNUM has a rotation speed selection button and speed indicator LEDs.

- **Slope alignment sights**

These sights are used to align the slope axis of the laser for excavating and grading when there is a slope required.

- **Laser Power indicator**

The green L.E.D. indicates the laser beam is on.

- **Low battery indicator**

The yellow L.E.D. indicates the batteries need to be replaced or charged.

- **Leveling indicators / H.I. alert**

A green L.E.D. in the upper leveling indicator control panel window turns on when the leveling system is active. A constant light indicates the laser is leveling. A flashing light indicates the laser is nearly level. When the laser is fully level, the rotating mirror begins to spin, the green power indicator L.E.D. comes on and the leveling L.E.D. turns off. If the laser cannot level, a red L.E.D. in the lower leveling indicator control panel window will flash. This indicates the tripod or surface the laser is on must be more level or closer to the slope that is dialed in.

When the laser finishes leveling and has been running for about five seconds, a feature called H.I. alert activates. When the laser enters this mode, the upper leveling indicator green L.E.D. will flash slowly five times. With H.I. alert active, if the laser is moved or bumped, or the grade knob is moved, the laser beam will shut-off, the rotor will stop spinning and the red and green leveling L.E.D.s will flash alternately. Any grade adjustments should be made before H.I. alert activates. To clear the H.I. alert, simply turn the laser off, then on again. You must recheck your setup before continuing your work to avoid errors.

- **Slope display**

The counter displays the amount of slope set into the plane of laser light. The display has a resolution of .01% and can be set from 0 to 25%.

- **Slope adjustment knob** (see H.I. alert above)

The slope adjustment knob is used to set slope into the laser, or to set the laser to level (00.00 slope).

- **Power switch**

The power switch turns the laser on or off.

- **Rotation speed selector** (MAGNUM only)

The rotation speed switch changes the rotation speed between 600, 900 and 1200rpm. The speed will stay at the last setting when the laser is shut down.

- **Rotation speed indicators** (MAGNUM only)

One of these indicators will be on whenever the laser is powered-up to indicate the selected rotation speed.

Precautions to follow when using any laser.

- Don't stare into the laser beam or view it directly with optical instruments.
- Don't disassemble the laser or attempt to service it.
- Don't use the laser until you have read the instruction manual and you are familiar with how to operate the laser properly.

U.S. OSHA requirements for operating visible lasers.

- Only qualified, trained employees may install, adjust and operate the laser.
- Laser operators must carry proof of qualification.
- The area of a job site where a laser is being used must be posted with a laser warning placard.
- The laser should be set up above or below eye level and never intentionally aimed at anyone.
- Turn the laser off when it is not being used, such as during lunch hour, at the end of the day, or during other long breaks in the work.

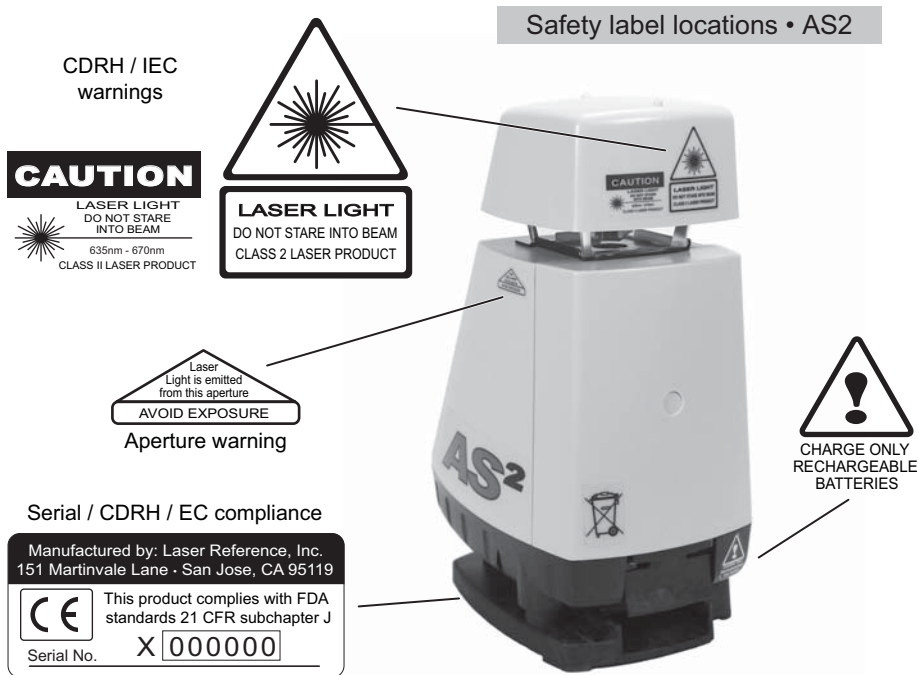

Note: The L1-AS is a CDRH class II laser and an IEC 60825 class 2 laser. The L1-ASM MAGNUM is a CDRH class IIIa laser and an IEC 60825 class 3R laser. Both models conform to applicable EC directives regarding RFI and EMI and to FDA performance standards 21 CFR subchapter J.

Safety label locations • AS2 MAGNUM

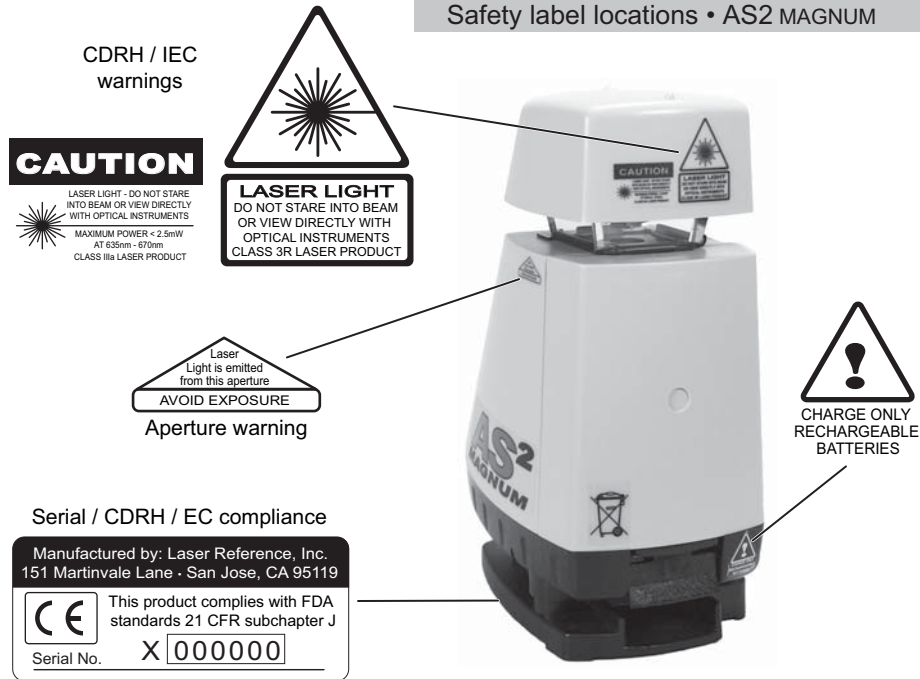

L1-ASM MAGNUM (IEC)

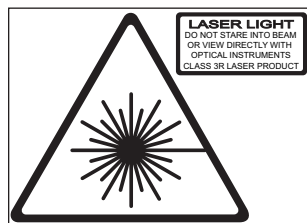

L1-ASM MAGNUM (CDRH)

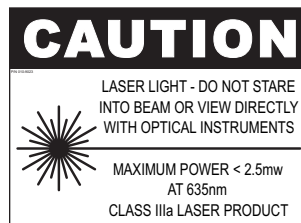

A warning placard is included with each laser and can be attached to the outside of the carrying case. The case can then be placed in a visible location near where the laser is being used in order to meet jobsite posting requirements.

L1-AS (IEC)

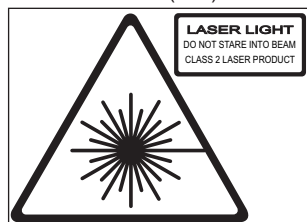

L1-AS (CDRH)

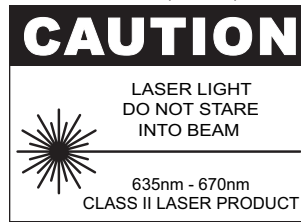

Calibration should be checked from time to time.

Although both AS2 models are calibrated at the factory and are exceptionally rugged lasers, it is well worth the effort to check calibration before you first use your laser (after shipping) and then from time to time to ensure that you are doing the highest quality work possible. Always check calibration if the laser has been handled roughly.

Check your setup.

Although not required, it is good jobsite practice when using any laser or optical instrument to check your setup from time to time. Use engineered benchmarks on the jobsite to assure that your setup is correct and matches the design of the job. Particularly on very large sites, or where accuracy is critical, taking a few minutes to verify the elevation marks you have been given to work from makes sense. Realize that even engineered benchmarks may not be perfect and enough verification must be done to be confident you are properly set up. If there are not suitable benchmarks on the site, you can set your own by driving stakes and recording their elevations, or by marking the laser beam height on stable objects such as telephone poles, concrete walls, etc. The benchmarks should be 90° apart for greatest accuracy. Having benchmarks to check is of great value for jobs where setups need to match day after day. If you will only be using the setup for a brief time, this may not be needed.

Work as close to the laser as possible.

You can work up to 1000 feet (305M) from the AS2 with the R7 receiver and 1650 feet (500M) from the AS2 MAGNUM using the R8 receiver or most brands/models of machine control receivers. As with all instruments, the farther you go, the more any error can add up. Set the laser in a safe place, as close as possible to your work.

Maintain your equipment.

Keeping tripod and mounting hardware tight, and being sure grade rods are in good condition, can prevent errors and performance problems.



Follow the instructions in the "initial setup guidelines" section (page 6).

Zero the grade display precisely.

Turn the laser on and allow it to level.

The aiming of the laser when working dead-level is not important.

In the event that a very long distance is required, the AS2 can be set-up in the middle of the site, covering a total diameter of 2000 feet (610 meters) using the R7 receiver. The AS2 MAGNUM can cover a 3300 foot (1000M) diameter using the R8 receiver, or most brands/models of machine control receivers.

Periodically check your setup against existing benchmarks or set and check benchmarks of your own.

Follow the suggestions in the "initial setup guidelines" section (page 6).

Carefully aim the laser using the sights on the top cap. These sights indicate the direction of slope. The front sloped face of the laser should be aimed uphill (as shown on the graphic just above the slope knob).

Using the red slope adjustment knob, adjust the slope display to your required slope. Note that if the laser has finished leveling and H.I. Alert has become active (see initial controls and displays pg. 2/3) you will need to turn the laser off, then on again to clear H.I. Alert.

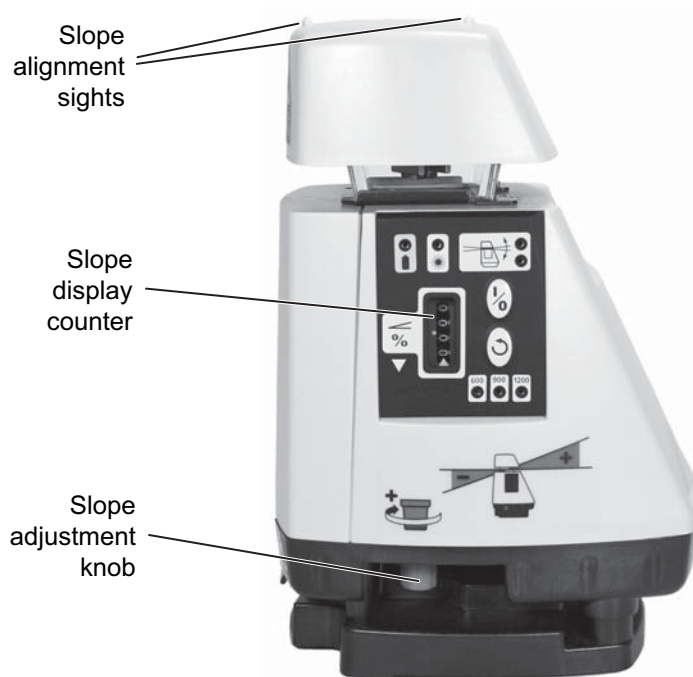

Note: When using either AS2 model at slope settings over 14%, you will need to tilt the tripod to allow the laser to reach the desired slope. By aligning the laser so that one tripod leg is to the rear (down slope side), you can shorten that leg to tilt the tripod head and the setup will remain stable.

Slope Setup

9

The display reads in percent of grade (the number displayed is the units of rise or fall per 100 units of run). A 2-1/2% slope (projecting upward from the front of the laser) shows as 2.50 on the display. If a down slope is needed, the display is set to the required slope and the rear of the laser is aimed in the direction of slope. The graphic label just above the slope knob shows the direction that upward or downward slopes are projected and the proper direction to turn the knob to increase or decrease the slope.

In order to be able to set an accurate zero percent slope (dead level), the counter can be turned below zero. When the counter on either model is turned to below zero, the upper counter digit will display a 9. This makes it obvious that the slope is set incorrectly and should be changed to zero (level), or to a positive slope setting. (see photo below)

This counter digit displays a 9 when the slope setting goes below zero.

Re-set the slope to zero (level), or to a positive slope setting when you see a 9 displayed here.

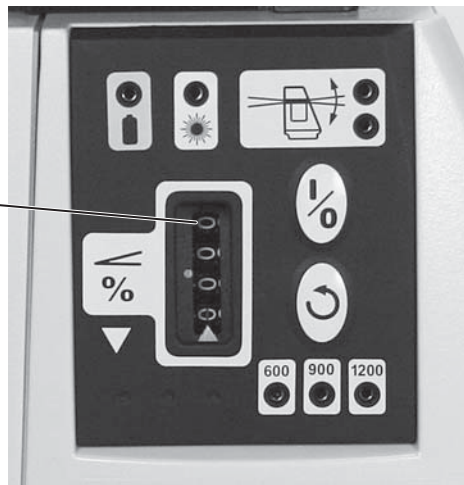

Regularly check your setup against benchmarks. If none are present, set at least two benchmarks of your own to monitor the accuracy of your setup.

The laser can be set at an offset to a ditch or excavation. Just be sure to point the sights on the top cap parallel to the direction of the slope.



S2 Compound slope adapter kit

Sites designed with compound slope actually have just a single resultant slope. When a site design has slope in two directions, 90 degrees apart, the optional model S2 Compound Slope Adapter Kit can be used to calculate and set the AS2 to the proper angle and resultant slope.

NOTE: The S2 kit is standard with the AS2 MAGNUM system.

In order to begin a compound slope setup, the S1 Compound Slope Adapter Kit must be installed on the laser, following the instructions included with the kit.

Next, follow the steps below and on page 11:

1. Determine the two slopes for the site and the direction of each slope. Set the compound slope adapter angle to zero (0) degrees and aim the laser parallel to the main slope on the site (the main slope is the steeper of the two slopes). Be certain that the up-slope direction of the laser is aimed uphill on the main slope. If there is any question which is the up-slope direction for the laser, you can refer to the label on the side of the laser just above the slope knob.

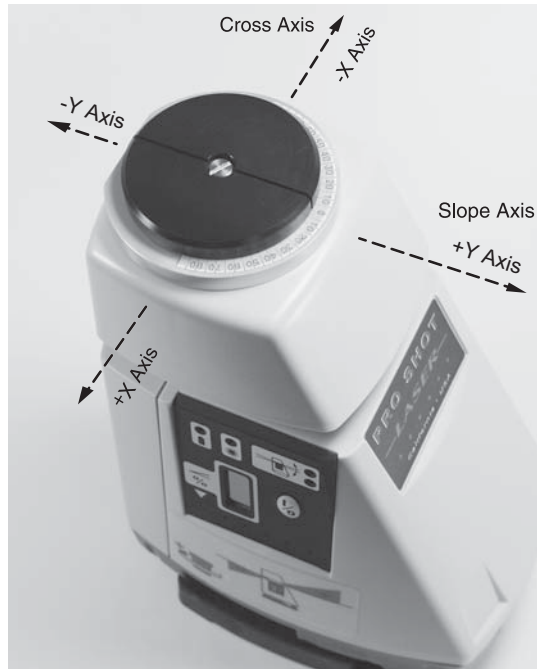

2. Using the compound slope chart supplied with the S2 kit, find the two slopes for the site on the chart and follow their row and column until they intersect. Remember that the main slope is the steeper of the two slopes. The upper number in the box where the two slopes intersect is the angle to set into the S2 adapter. The lower number is the resultant slope to dial into the laser's slope counter. Note: The slope number is displayed with greater precision than the slope counter increments.
3. Rotate the S2 adapter until it matches the angle determined with the slope chart. Note: if, when standing behind the laser, the highest corner on the site is to the right of the grade sight, you must rotate the adapter counter clock-wise until you reach the proper reading. If the high corner is to the left, you must rotate the adapter clock wise.
4. Turn the entire laser toward the uphill direction of the cross slope (toward the highest corner on the site) until the slope alignment sight is once again aligned parallel to the main slope. The laser is now at the proper angle.
5. To finish the setup, dial in the resultant slope determined from the chart and go to work. Note: you can re-check the setup at any time by doing the following: A. Verify the slope counter setting. B. Verify that the proper angle is set into the compound slope adapter. C. Verify that the slope sighting slot is parallel with the main slope direction. D. Verify that the uphill direction of the laser is aimed toward the high corner of the site.

Always set at least two grade checking stakes that are 90 degrees apart so that you can verify the laser setup from day to day on the site.

Compound slope example

1. Zero the compound slope adapter ring and aim the laser parallel to the main slope, with the up-slope direction of the laser aimed up-hill on the site.
2. Look-up the intersection of the main slope (.25) and the cross slope (.15) using the slope chart. The box at the intersection looks like this:

31
0.292
3. Turn the adapter sighting slot 31° counter clock-wise.
4. Turn the entire laser to re-align the sighting slot parallel with the main slope. (the laser is now aimed 31° toward the high corner).
5. Dial the resultant slope of .29% into the slope counter. Setup is complete.

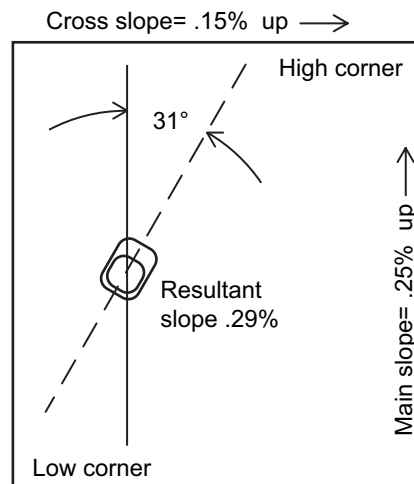

Calibration is your responsibility, check it often.

Although both AS2 models are calibrated at the factory and are exceptionally rugged lasers, it is well worth the effort to check calibration before you first use your laser (after shipping) and then from time to time to ensure that you are doing the highest quality work possible. Always check calibration if the laser has been handled roughly.

Follow the steps below to check the calibration of the laser and make necessary adjustments.

1. Attach the laser to a flat head tripod approximately 100 feet from a wall or other stable vertical surface (a telephone pole or concrete building will work well). We will call the vertical surface the target. The tripod head must be level enough to allow you to turn the laser 360 degrees with minimal re-leveling needed. Use the tripod leg adjustments to get the tripod head level.

2. Rotate the entire laser so that either direction of the cross (X) axis (see picture) is aimed at the target.

3. Carefully set the slope display counter to 00.00 (The red stripe on the last counter digit should be aligned with the pointer). Turn the laser on and allow it to level.

4. Take the receiver to the target and find the height of the laser beam by moving the receiver up or down until you get a display and/or tone. Now, find the center of the display and mark the target, using the receiver's beam center notch as a guide.



5. Return to the laser and rotate it 180 degrees. Allow the laser to re-level. The opposite cross axis (X) direction is now aimed at the target. Find and mark the laser beam height (see step 4).
6. The difference between the two marks (if any) is double the difference between how the laser is calibrated and true level for the cross axis. Half way between these two marks is true level. Make a long mark at true level. If the difference between either outer mark and true level is within your working tolerance, go on to step 10. If not, continue with the next step.
7. Remove the battery door and the rubber plug on the lower left side of the battery holder. The four button switches inside control the calibration of the laser. Each push of a button moves the calibration by approximately 3 arc seconds (approx. 1/64" @100' / .4mm @30m). A small screwdriver, allen wrench or even a dull pencil can be used to press the buttons. The label below the opening shows which direction each button will move each axis. Press the + or - button corresponding to the X axis the number of times estimated to bring the beam to the true level mark. Go to the target surface and check the beam elevation. If the elevation is correct, go on to step 8. If not, continue to press the button until the beam comes to level.
8. Check the cross axis adjustment by rotating the laser back to the first direction and letting the laser re-level. Check that the reading is within the needed tolerance of the true level mark.
9. Rotate the laser 90 degrees to aim the front of the slope axis at the target (+Y axis). Allow the laser to re-level and check the reading at the target. If the reading is on, or within tolerance of the true level mark, calibration is complete. If not, continue on.
10. Verify the counter is set to exactly 00.00. Remove the battery door and the rubber plug on the lower left side of the battery holder. The four button switches inside control the calibration of the laser. Each push of a button moves the calibration by approximately 3 arc seconds (approx. 1/64" @100' / .4mm @30m). A small screwdriver, allen wrench or even a dull pencil can be used to press the buttons. The label below the opening shows which direction each button will move each axis. Press the + or - button corresponding to the Y axis the number of times estimated to bring the beam to the true level mark. Go to the target surface and check the beam elevation. If the elevation is correct, put the rubber plug back in. If not, continue to press the button until the beam comes to level.

Calibration is now complete.

The R7 senses the plane of laser light projected by the AS2 and indicates a height position relative to the plane (high, low, or on grade). The R7 uses a five channel front LCD to display height information and a three channel rear LED display. Along with the visual displays, an audio tone also indicates when the receiver is high, low, or on grade. When the R7 is exactly centered at the beam height, an on grade "bar" indication is displayed. If the R7 is high or low, an "arrow" shows the direction to move the R7 in order to get an on grade indication.

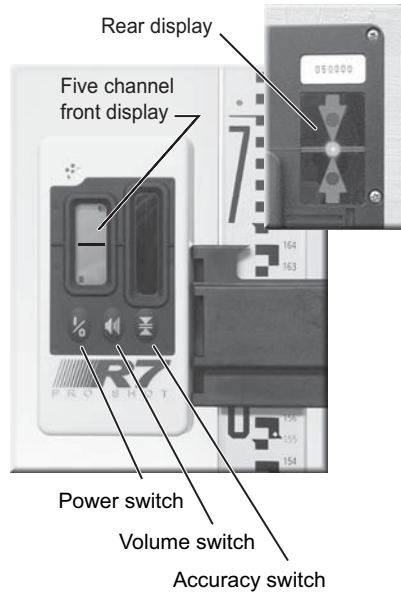

The R7 has three control switches, power on/off, tone high/low/off and on-grade accuracy select. Pressing the power switch activates the R7. The audio tone will sound and the LCD display will show the tone and accuracy icons. The R7 is ready to operate in standard accuracy with loud tone. Pressing the volume switch once changes to low volume, twice turns the volume off. When the volume is off, there will still be a single tone the first time the R7 senses a laser signal. Pressing the accuracy switch once changes to the coarse setting, twice changes to fine. The R7 automatically turns off if no laser beam strikes are received for twelve minutes. The R7 is powered by a 9 volt battery that lasts approximately 60 hours. When the battery is nearly used up, the low battery indicator will be displayed. To replace the battery, locate the battery door on the back of the housing and slide the door toward the bottom of the receiver. Remove the battery from the compartment (you may need to tap the R7 on your palm to free the battery). Replace the battery following the diagram molded on the battery door.

Specifications and display icons

Reception Height	2 inches (50mm)
Reception Angle	120 degrees
Standard mode accuracy	±1/16 in. (±1.6mm) nominal
Coarse mode accuracy ...	±1/8 in. (±3.2mm) nominal
Ultra-fine mode accuracy	±1/64 in. (±.4mm) nominal
Power Supply	9 volt battery
Battery life (alkaline)	60 hours continuous
Automatic Shut Off	After 12 min. (no laser strikes)
Environmental	Sealed against dust and water
Rotation Compatibility ...	250 to 850 R.P.M.
Mount Clamping Range	5/8in to 2-1/2in (16mm-65mm)

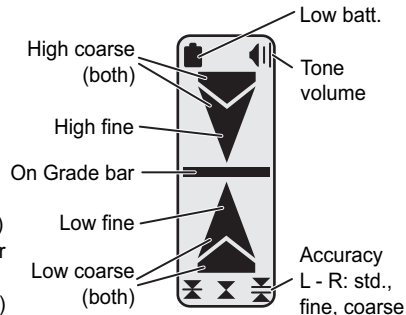

The R8 senses the plane of laser light projected by the AS2 MAGNUM and indicates a height position relative to the plane (high, low, or on grade). The R8 uses five channel front and rear LCDs to display height information. Along with the visual displays, an audio tone also indicates when the receiver is high, low, or on grade. When the R8 is exactly centered at the beam height, an on grade "bar" indication is displayed. If the R8 is high or low, an "arrow" shows the direction to move the R8 in order to get an on grade indication.

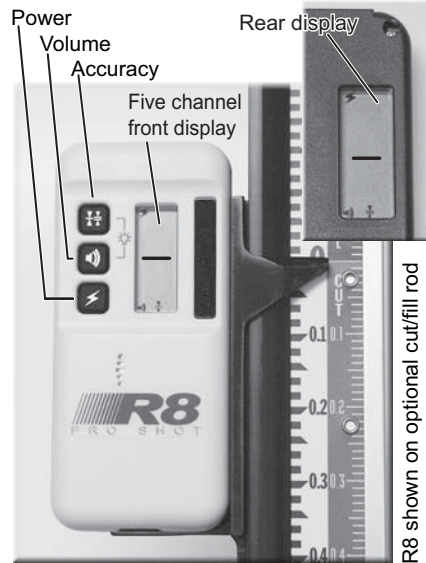

The R8 has three control switches, power on/off, tone high/low/off and on-grade accuracy select. Pressing the power switch activates the R8. The audio tone will sound and the LCD display will show the power, tone and accuracy icons. The R8 is ready to operate in standard accuracy with loud tone. Pressing the volume switch once turns the volume off, twice changes to low volume. When the volume is off, there will still be a single tone the first time the R8 senses a laser signal. Pressing the accuracy switch once changes to the coarse setting (note: display is 3 channels in coarse), twice changes to fine. The R8 automatically turns off if no laser beam strikes are received for 30 minutes. The R8 is powered by two AA cell batteries that last approximately 70 hours. When the battery is nearly used up, the low battery indicator will be displayed. To replace the batteries, locate the battery door on the lower back of the housing and open the latch using a coin. Replace batteries following the + diagram on the housing.

Specifications and display icons

Reception Height	2 inches (50mm)
Reception Angle	90 degrees
Standard mode accuracy	±1/16 in. (±1.6mm) nominal
Coarse mode accuracy ...	±1/8 in. (±3.2mm) nominal
Ultra-fine mode accuracy	±1/32 in. (±.8mm) nominal
Power Supply	2 AA cell batteries
Battery life (alkaline)	70 hours continuous
Automatic Shut Off	After 30 min. (no laser strikes)
Environmental	Sealed against dust and water

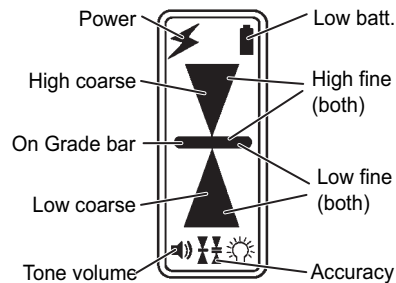

Calibration • There is no set interval for calibrating either AS2 model, but calibration should be checked from time to time in order to ensure that the highest possible quality of work is being done. Calibration should always be checked if the laser has been handled roughly or shipped.

Batteries • Occasionally remove the batteries and check the contacts for corrosion. Alkaline batteries will last far longer than carbon batteries. If you use rechargeable batteries, be careful to never charge alkaline or carbon batteries. Never run the laser from the charger unless there are rechargeable batteries installed. Keep a spare set of batteries in the carrying case to avoid down time.

Laser output windows • Regularly check the output windows for dust and dirt. Dust can be removed with a camera brush or clean compressed air.

Control panel and exterior • Clean the control panel and the other exterior surfaces of the laser with a soft damp cloth.

Caution! • Never store the laser in a carrying case that is wet inside. Moisture can get inside the laser this way. Should this happen, remove the battery cover and place the laser in a warm area until it is completely dry.

Troubleshooting

The laser will not operate, there is no obvious damage • If the low battery indicator is on, or you suspect the batteries may be dead, replace the batteries. Check the battery contacts to be sure that they are clean.

The receiver shows an on-grade at two different heights • Check the jobsite for windows or mirrored surfaces that might be reflecting the laser and causing the other reading. Check for others on the site using a rotary laser.

The laser was knocked over • Visually check the optics for damage. Inspect the laser for any other physical damage. Use the receiver to check that the laser is transmitting. Check the calibration and adjust as needed.

The laser only works at short distances • Check the output windows for heavy dust or moisture. Remove dust with a camera brush or blow off gently with clean compressed air. Allow moisture to dry.

The receiver does not indicate "on grade" at long distance • Be sure you are within the max distance specification from the laser. Check the windows that surround the rotating mirror on the laser for dust or moisture. Remove dust with a camera brush or blow off gently with clean compressed air. Allow moisture to dry.

Guardian 36 month warranty coverage

The AS2 and AS2 MAGNUM laser transmitters, along with the R7 receiver, are warranted for thirty-six (36) months from the date of new equipment purchase from an authorized dealer. The R8 receiver is warranted for twenty-four (24) months. During the warranty period, Laser Reference, or its authorized service center, will repair or replace, at Laser Reference's sole discretion, laser transmitters or receivers, free of charge, (except for transportation costs) if the products are found by Laser Reference, or its authorized service center, to be defective in either materials or workmanship. The Guardian 36 month warranty also covers the internal leveling mechanism and internal optics (parts only, not labor) against damage from any cause. Maintaining the calibration of the product is not the responsibility of Laser Reference or its authorized service centers. If service is needed, the product(s) must be sent FREIGHT PREPAID to the nearest authorized service center or to Laser Reference.

Specifications

Range with receiver • AS ²	1000' rad., 2000' dia. (305m/610m)
AS² MAGNUM	1650' rad., 3300' dia. (500m/1000m)
Leveling accuracy • AS ²	±14 arc seconds (2.0mm per 30m)
	(.080" per 100')
AS² MAGNUM	±10 arc seconds (1.5mm per 30m)
	(.060" per 100')
Slope Capability	0-25%, single axis, .01% increments
Compound slope capability ...	S2 compound slope kit optional
AS² MAGNUM	S2 compound slope kit included
Self-Leveling Range	±4 Degrees
Rotation speed • AS ²	600rpm
AS² MAGNUM	600, 900, 1200rpm (selectable)
Power Supply	Four C-cell batteries (alkaline std.)
Rechargeable Batteries	Available option (NiMh)
Run Time (continuous) • AS ² ..	115 hrs. (alkaline) / 95 hrs. (NiMh)
AS² MAGNUM	70 hrs. (alkaline) / 55 hrs. (NiMh)
Automatic Shut-off	If off-level for more than 3 min.
Environmental	Dust and water resistant (IP55)
Operating Temp. • AS ²	14°f to +122°f (-10°c to +50°c)
AS² MAGNUM	14°f to +140°f (-10°c to +60°c)
Storage Temperature	-40°f to +140°f (-40°c to +60°c)
AS ² Laser rating	CDRH Class 2 • IEC 825-1 Class 2
AS² MAGNUM Laser rating ..	CDRH Class 3A • IEC 825-1 Class 3R
Height / Weight	9.7in (24.5cm) / 4.4lbs (2.0kg)



**Laser Reference, Inc.
151 Martinvale Lane
San Jose, CA 95119 • USA**

Toll Free (USA) • +1.800.238.0685
Telephone • +1.408.361.0220
Fax • +1.408.361.3180
Web • www.proshotlaser.com
Email • sales@proshotlaser.com



Customer information

Laser Serial number _____

Receiver S/N _____

Date of purchase _____